

HiPerFAST™ IGBT

B2-Class High Speed IGBTs

IXGH 50N90B2
IXGT 50N90B2

$V_{CES} = 900 \text{ V}$
 $I_{C25} = 75 \text{ A}$
 $V_{CE(sat)} = 2.7 \text{ V}$
 $t_{fi\text{typ}} = 200 \text{ ns}$

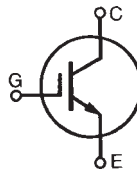

Symbol	Test Conditions	Maximum Ratings	
V_{CES}	$T_J = 25^\circ\text{C}$ to 150°C	900	V
V_{CGR}	$T_J = 25^\circ\text{C}$ to 150°C ; $R_{GE} = 1 \text{ M}\Omega$	900	V
V_{GES}	Continuous	± 20	V
V_{GEM}	Transient	± 30	V
I_{C25}	$T_C = 25^\circ\text{C}$ (limited by leads)	75	A
I_{C110}	$T_C = 110^\circ\text{C}$	50	A
I_{CM}	$T_C = 25^\circ\text{C}$, 1 ms	200	A
SSOA (RBSOA)	$V_{GE} = 15 \text{ V}$, $T_{VJ} = 125^\circ\text{C}$, $R_G = 10 \Omega$ Clamped inductive load @ $\leq 600\text{V}$	$I_{CM} = 100$	A
P_C	$T_C = 25^\circ\text{C}$	400	W
T_J		-55 ... +150	$^\circ\text{C}$
T_{JM}		150	$^\circ\text{C}$
T_{stg}		-55 ... +150	$^\circ\text{C}$
Maximum lead temperature for soldering 1.6 mm (0.062 in.) from case for 10 s		300	$^\circ\text{C}$
M_d	Mounting torque (TO-247)	1.13/10Nm/lb.in.	
Weight		TO-247 AD	6 g
		TO-268	4 g

TO-247
(IXGH)

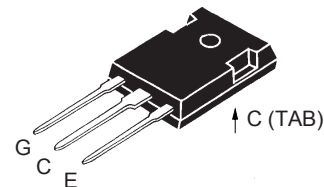

TO-268
(IXGT)

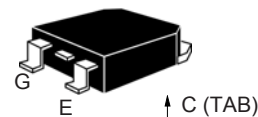

G = Gate,
E = Emitter,

C = Collector,
TAB = Collector

Features

- High frequency IGBT
- High current handling capability
- MOS Gate turn-on
- drive simplicity

Applications

- PFC circuits
- Uninterruptible power supplies (UPS)
- Switched-mode and resonant-mode power supplies
- AC motor speed control
- DC servo and robot drives
- DC choppers

Advantages

- High power density
- Very fast switching speeds for high frequency applications

Symbol	Test Conditions	Characteristic Values ($T_J = 25^\circ\text{C}$, unless otherwise specified)		
		min.	typ.	max.
$V_{GE(th)}$	$I_C = 250 \mu\text{A}$, $V_{CE} = V_{GE}$	3.0		5.0 V
I_{CES}	$V_{CE} = V_{CES}$ $V_{GE} = 0 \text{ V}$			50 μA 1 mA
I_{GES}	$V_{CE} = 0 \text{ V}$, $V_{GE} = \pm 20 \text{ V}$			$\pm 100 \text{ nA}$
$V_{CE(sat)}$	$I_C = I_{C110}$, $V_{GE} = 15 \text{ V}$		2.2	2.7 V
				$T_J = 125^\circ\text{C}$

Symbol	Test Conditions	Characteristic Values ($T_J = 25^\circ\text{C}$, unless otherwise specified)			
		min.	typ.	max.	
g_{fs}	$I_C = I_{C110} A$; $V_{CE} = 10\text{ V}$, Pulse test, $t \leq 300\ \mu\text{s}$, duty cycle $\leq 2\%$	25	40	S	
C_{ies} C_{oes} C_{res}	$V_{CE} = 25\text{ V}$, $V_{GE} = 0\text{ V}$, $f = 1\text{ MHz}$		2500	pF	
			180	pF	
			75	pF	
Q_g Q_{ge} Q_{gc}	$I_C = I_{C110} A$, $V_{GE} = 15\text{ V}$, $V_{CE} = 0.5 V_{CES}$		135	nC	
			23	nC	
			50	nC	
$t_{d(on)}$ t_{ri} $t_{d(off)}$ t_{fi} E_{off}	Inductive load, $T_J = 25^\circ\text{C}$ $I_C = I_{C110} A$, $V_{GE} = 15\text{ V}$ $V_{CE} = 720\text{ V}$, $R_G = R_{off} = 5\ \Omega$		20	ns	
			28	ns	
			350	500	ns
			200		ns
			4.7	7.5	mJ
$t_{d(on)}$ t_{ri} E_{on} $t_{d(off)}$ t_{fi} E_{off}	Inductive load, $T_J = 125^\circ\text{C}$ $I_C = I_{C110} A$, $V_{GE} = 15\text{ V}$ $V_{CE} = 720\text{ V}$, $R_G = R_{off} = 5\ \Omega$		20	ns	
			28	ns	
			0.7		mJ
			400		ns
			420		ns
			8.7		mJ
R_{thJC} R_{thCK}	(TO-247)			0.31 KW KW	
		0.25			

Min. Recommended Footprint (Dimensions in inches and mm)

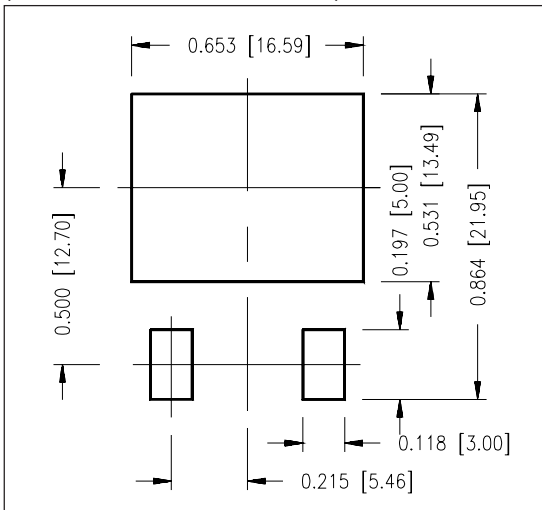

TO-247 AD Outline

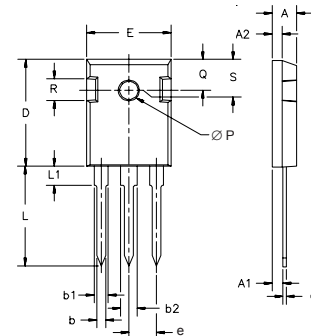

Dim.	Millimeter		Inches	
	Min.	Max.	Min.	Max.
A	4.7	5.3	.185	.209
A ₁	2.2	2.54	.087	.102
A ₂	2.2	2.6	.059	.098
b	1.0	1.4	.040	.055
b ₁	1.65	2.13	.065	.084
b ₂	2.87	3.12	.113	.123
C	.4	.8	.016	.031
D	20.80	21.46	.819	.845
E	15.75	16.26	.610	.640
e	5.20	5.72	0.205	0.225
L	19.81	20.32	.780	.800
L1		4.50		.177
∅P	3.55	3.65	.140	.144
Q	5.89	6.40	0.232	0.252
R	4.32	5.49	.170	.216
S	6.15	BSC	.242	BSC

TO-268 Outline

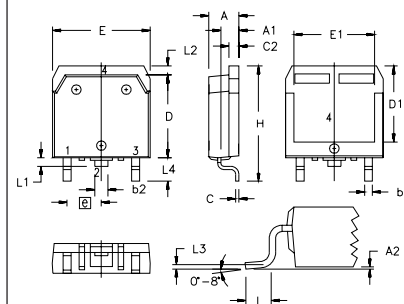

SYM	INCHES		MILLIMETERS	
	MIN	MAX	MIN	MAX
A	.193	.201	4.90	5.10
A1	.106	.114	2.70	2.90
A2	.001	.010	0.02	0.25
b	.045	.057	1.15	1.45
b2	.075	.083	1.90	2.10
C	.016	.026	0.40	0.65
C2	.057	.063	1.45	1.60
D	.543	.551	13.80	14.00
D1	.488	.500	12.40	12.70
E	.624	.632	15.85	16.05
E1	.524	.535	13.30	13.60
e	.215 BSC		5.45 BSC	
H	.736	.752	18.70	19.10
L	.094	.106	2.40	2.70
L1	.047	.055	1.20	1.40
L2	.039	.045	1.00	1.15
L3	.010 BSC		0.25 BSC	
L4	.150	.161	3.80	4.10

IXYS reserves the right to change limits, test conditions, and dimensions.

IXYS MOSFETs and IGBTs are covered by one or more of the following U.S. patents:	4,850,072	4,931,844	5,034,796	5,063,307	5,237,481	5,381,025	6,404,065B1	6,162,665	6,534,343	6,583,505
	4,835,592	4,881,106	5,017,508	5,049,961	5,187,117	5,486,715	6,306,728B1	6,259,123B1	6,306,728B1	6,683,344

Fig. 1. Output Characteristics
@ 25 °C

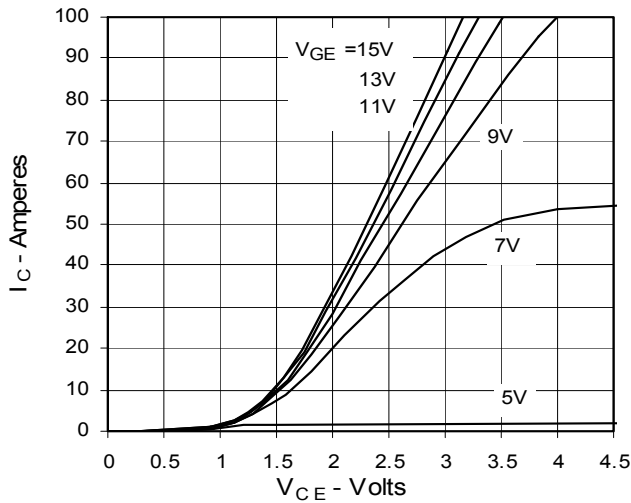

Fig. 2. Extended Output Characteristics
@ 25 °C

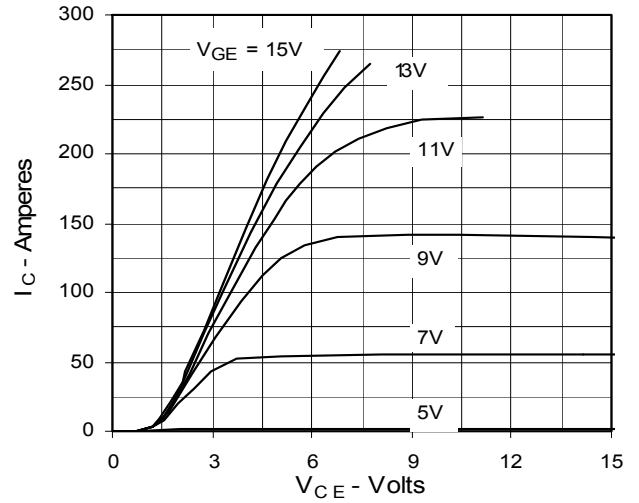

Fig. 3. Output Characteristics
@ 125 °C

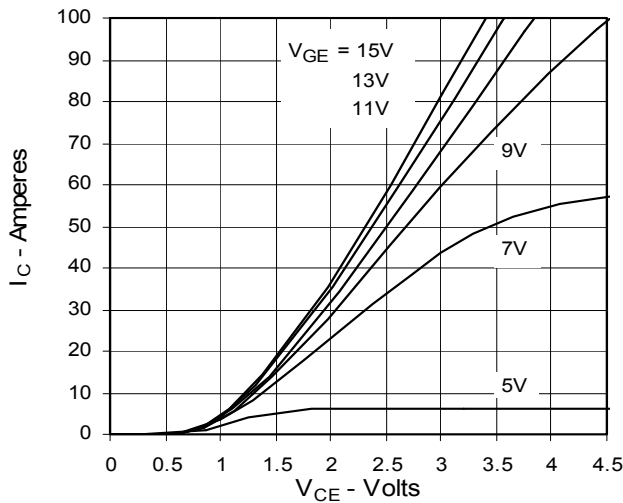

Fig. 4. Dependence of $V_{CE(sat)}$ on Temperature

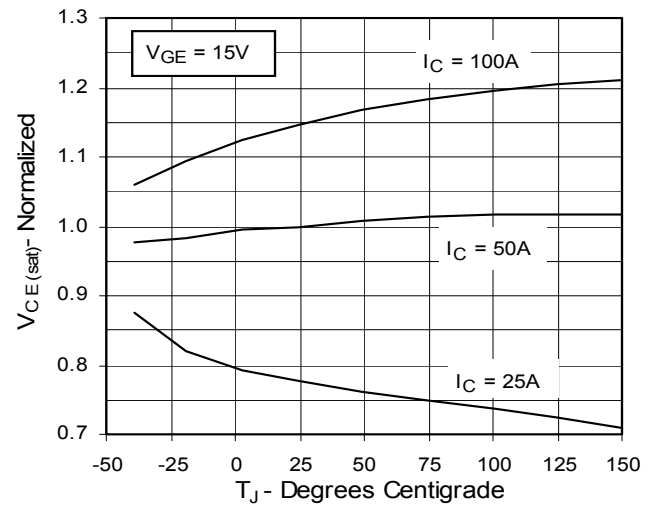

Fig. 5. Collector-to-Emitter Voltage vs. Gate-to-Emitter voltage

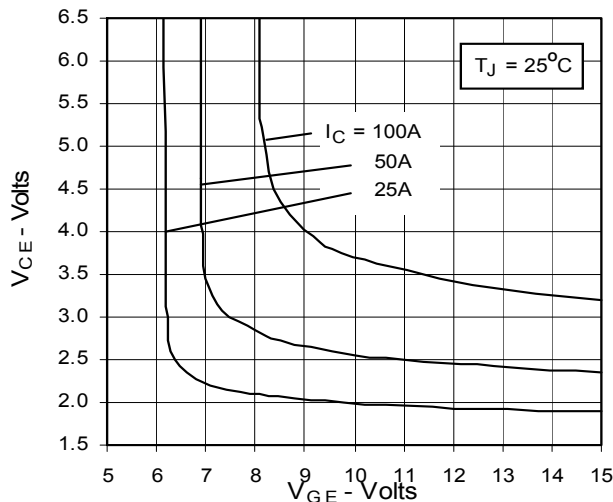

Fig. 6. Input Admittance

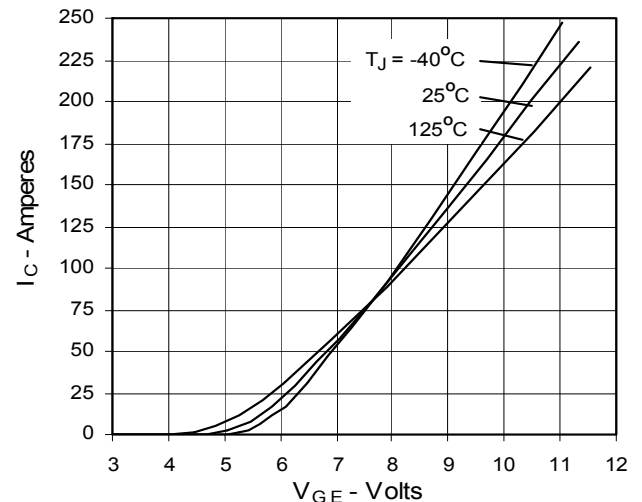

Fig. 7. Transconductance

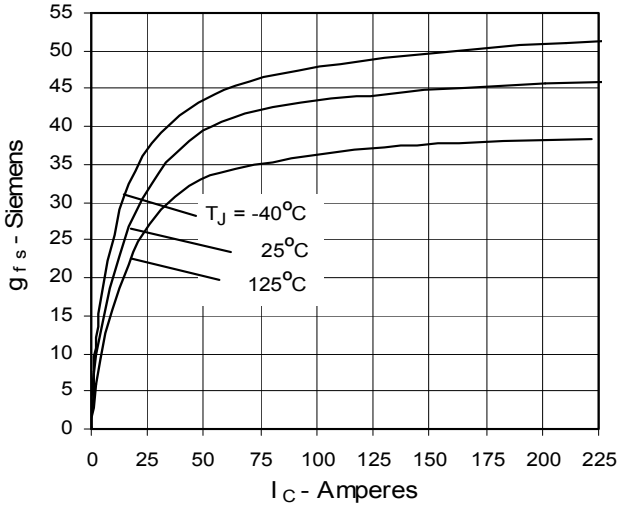

Fig. 8. Dependence of Turn-off Energy Loss on R_G

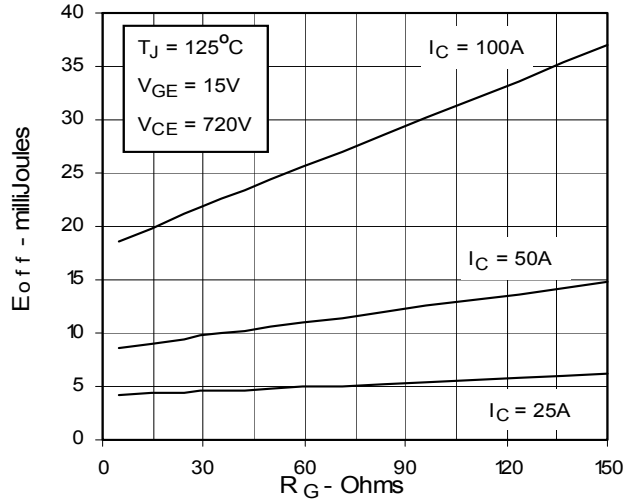

Fig. 9. Dependence of Turn-Off Energy Loss on I_C

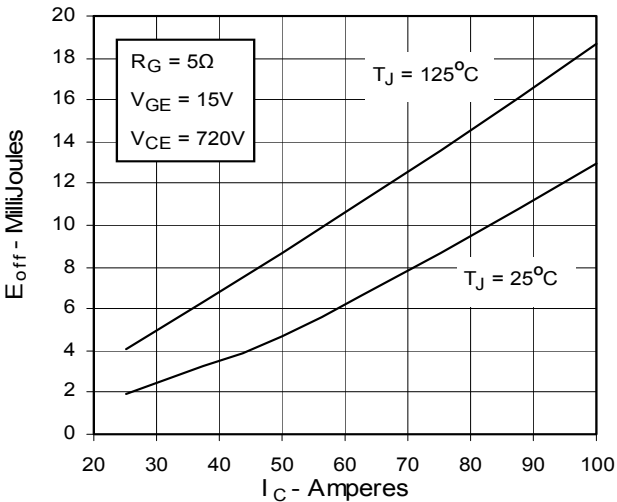

Fig. 10. Dependence of Turn-off Energy Loss on Temperature

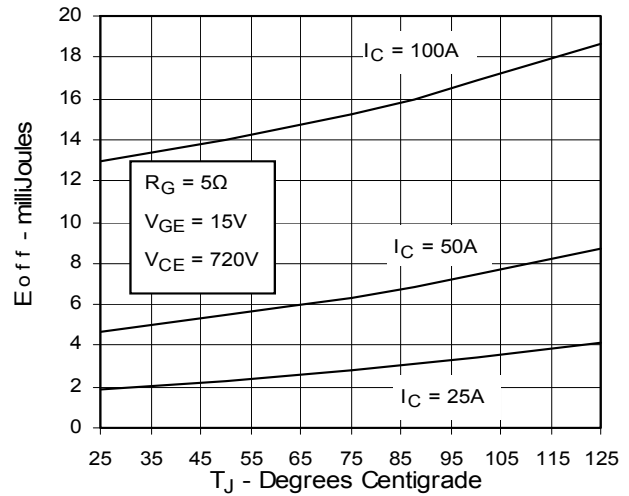

Fig. 11. Dependence of Turn-off Switching Time on R_G

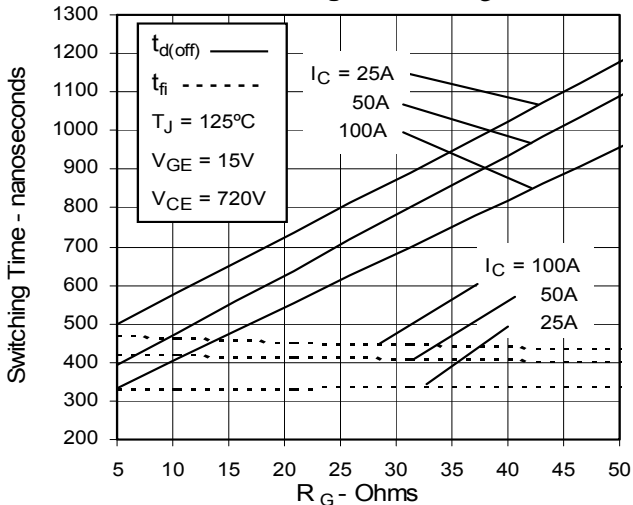
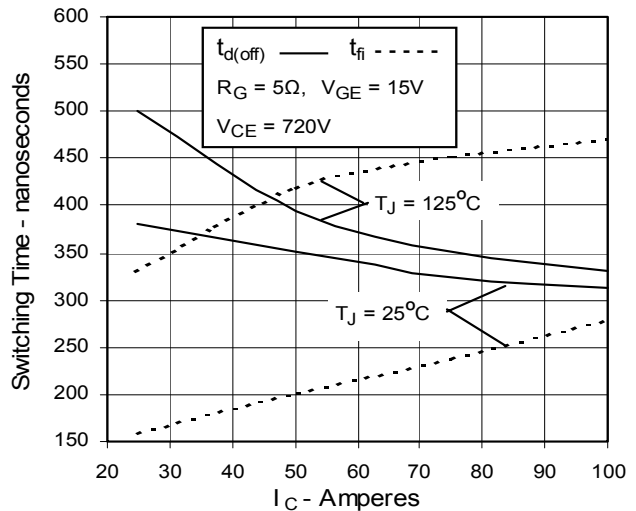

Fig. 12. Dependence of Turn-off Switching Time on I_C



IXYS reserves the right to change prices, specifications, and dimensions

Fig. 13. Dependence of Turn-off Switching Time on Temperature

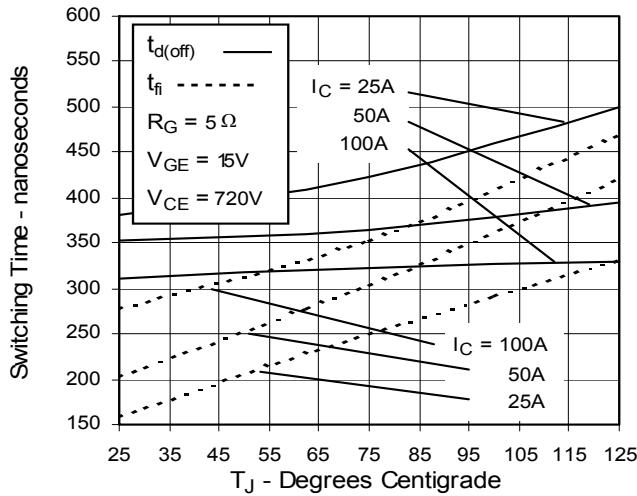

Fig. 14. Gate Charge

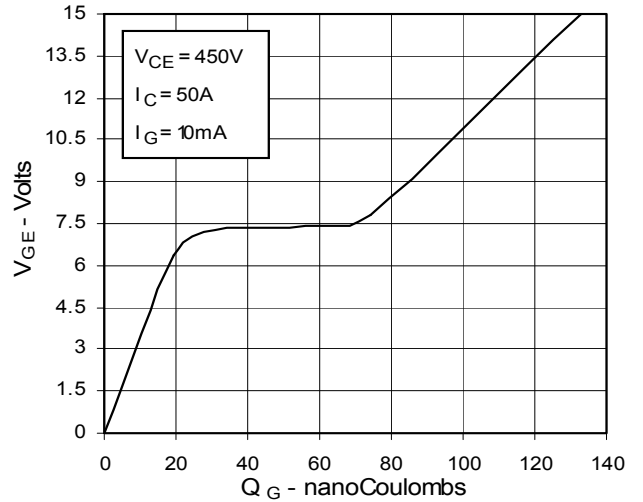

Fig. 15. Capacitance

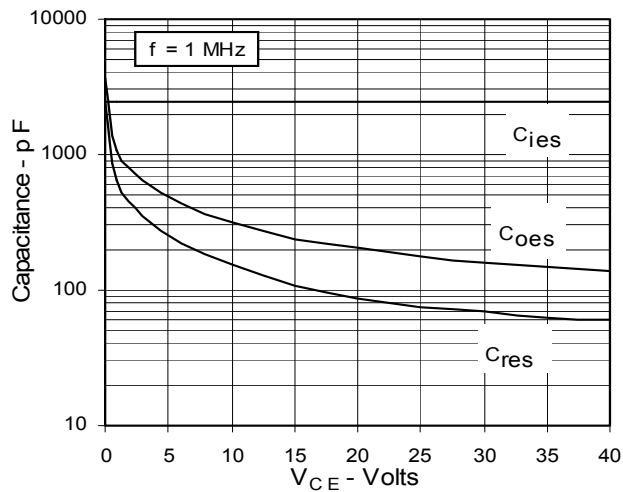

Fig. 16. Reverse-Bias Safe Operating Area

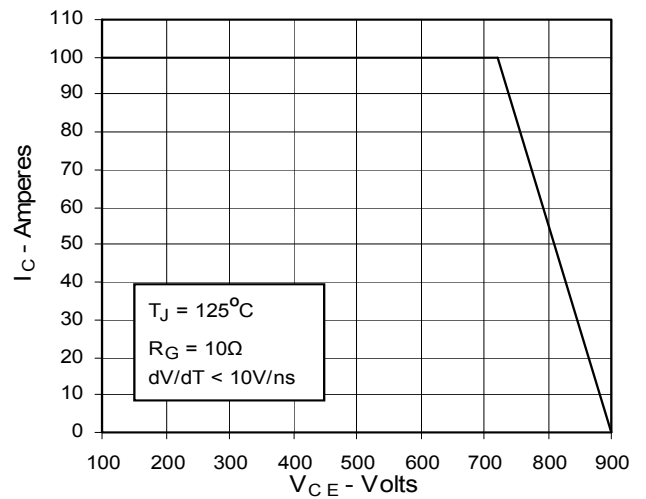

Fig. 17. Maximum Transient Thermal Resistance

